



Instruction Manual

Digital Blood Pressure Monitor
(Upper Arm)



BSX516

*Please thoroughly read the instruction Manual before using the unit.
*Please save this instruction Manual for further reference

□ Safety Information

Please carefully read the important safety information before operating the unit, in order to use it correctly.

⊙ This device is only intended for use in measuring blood pressure and pulse rate in adult population. Do not use this unit for any other purpose.

⊙ The monitor is not intended to be a diagnostic device. Self-diagnosis and treatment using measured results may be dangerous. Follow the instructions of your physician

⊙ For the users with upper limb disability, please consult your doctor for the permission to use this unit.

⊙ During the operating time, if the cuff is over-inflated, the pressure possibly makes user not comfortable. Please press “start/stop” button immediately to deflate the pressure, or take the air tube plug off and remove the cuff from upper arm.

⊙ Use only authorized parts and accessories, such as, cuff, battery.

⊙ Do not disassemble or attempt to repair the unit or components.









Safety Symbols	Indication
 Warning	Indicates a potentially hazardous situation which, if not operated correctly, could result in serious injury
 Caution	Indicates a potentially hazardous situation which, if not operated correctly, may result in minor or moderate injury to the user or patient or damage to the equipment or other property
	Warranty time
	Pressure up symbol
	Pressure down symbol
	Heart Symbol
	Type B
	Dispose of the device, components and optional accessories according to applicable local regulations to protect environmental pollution
	Refer to Instruction Manual

Table of Contents

Blood Pressure Monitor(Upper Arm type)

Safety information	1
Table of Contents	2
Foreword	3
I.Unit Structures & accessories	
Know your Unit.....	4
LCD Display introduction	5
II. Preparation	
Battery Installation.....	6
Battery Indicator.....	6
III.User Setting.....	6
IV. Operating the Monitor	
Applying the arm cuff.....	7
Taking a measurement.....	8
Error Indicators and Cause.....	10
V.Care, Maintenance & Calibration.....	11
VI.Disposal Statement	11

Components List

1.Monitor	1□
2.Arm Cuff	1□
3.Instruction Manual	1□
4.4*AA Batteries	1□

Foreword

Thank you for purchasing our company's automatic blood pressure monitor (Upper Arm type). Blood pressure is one of important indicator to reflect human blood circulatory system. The home blood pressure monitor is easy to use frequently. It is very significant to prevent cardiovascular disease, to improve the initiative of hypertension patient for treatment, and to control the high blood pressure.

The automatic blood pressure monitor can measure the upper and lower pressure value simultaneously by fuzzy logic control. Personalized inflation leads to the result of value every time. It is effective to reduce the discomfort by wrongly inflating the arm cuff and also to reduce the wrong measurement value, thus, it improves the accuracy of the measurement.

The automatic blood pressure monitor can store up to 99 sets of measurement value for two users in memory. Meanwhile, it can display the latest 3 sets of average measurement value.

The blood pressure monitor has different features to meet different users' need.

Please kindly read the instruction manual with the relevant Model your purchased and notice the difference between them.

Please read the Instruction Manual thoroughly before using this unit and please consult your physician for the specific information about your blood pressure.

I. Unit Structures & accessories

1. Main Unit

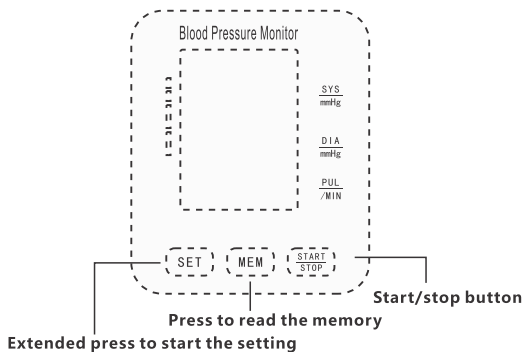

2. Cuff

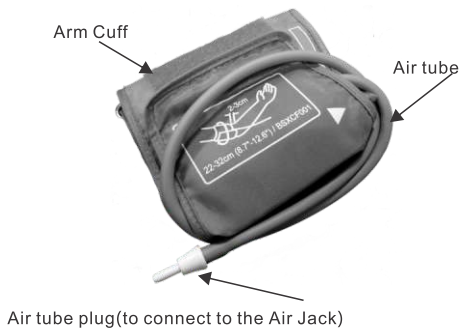

The above picture is only for reference.
Please use the material object as standard

3. LCD Display Introductions

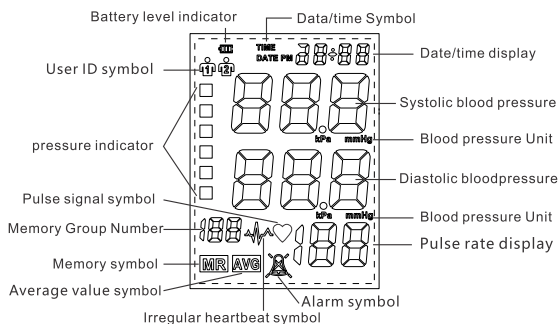

4. Circuit diagram

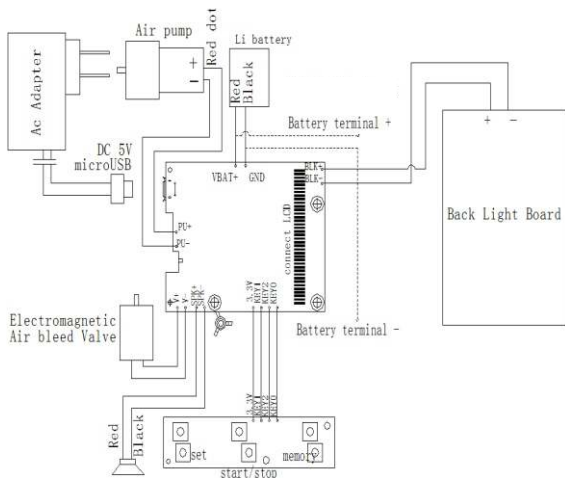

II. Preparation



1. Battery Installation

1) Turn the monitor upside down, press the round cover of battery, push to the direction of arrow to remove the cover. Insert 1.5V 4 *AA batteries (R6) into the battery compartment, and then replace the battery cover.

2) Also can use the accessory 5V \Rightarrow 1A AC adapter to supply the power by inserting Micro USB into the left jack.

2. Battery level Introduction

1) In shutdown mode, Press the Start/Stop button/memory button/setting button to enter into measuring pattern/recording pattern/setting pattern. When it displays, system will detect the battery level and will indicate the level on LCD display. Details are as follows:

i. Battery Level Full. Display the battery full icon () or the battery icon (), can take measurement and read the memory.

ii. Battery Level Low. Indicate the battery level low symbol (), still can take measurement and read the memory. Please timely charge your battery or replace new batteries .

iii. Battery Exhausted. Out of battery symbol (). It flashes 5 times and monitor will shut off immediately.

III. User Setting

1. Switch User

In shutdown mode, short press the setting button to enter into the time pattern. It displays Unit symbol, user symbol, time symbol. Time and date switch in 3 seconds. In time pattern mode, short press setting button to switch user. Extended press will be no responses. Press **【Start/Stop】** button to store the setting.

2. Setting Date and time

Under shutdown mode, Extended press the setting button to set the date. Press memory button to set year , then press setting button, Month flashes(500ms/500ms)to set month;
Press memory button to set month, then press setting button, Date flashes, to set the date;
Press memory button to set date, then press setting button, Hour symbol flashes, to set the hours;
Press memory button to set hours, then press setting button to set hours. Afternoon displays PM (if set up 24hrs, will not display PM)
Press memory button to set hours, then press setting button, minute flashes, to set the minute;
Press memory button to set minute. Minute setting up completed. After this,

Then press Setting button. Turn off the monitor to store the setting. At this moment, the setting will be both stored by turning off manually or automatically shutting down in 60 seconds .

3.Switch the unit of measurement

In the shutdown mode, long press **【Start/Stop】** button by 15 seconds. Long press will switch the unit, mmHg to kPa. LCD display will appear 0.0kpa and this shows the sitting being set successfully. Press **【Start/Stop】** button to turn off the monitor to store the setting.

4.Read the Memory

First press memory button, AVG& MR symbol lightens and display the latest 3 times average value(When the memory is more than 3 sets).

Second press memory button, MR symbol lightens. Long press the memory button to read the memory.

5. Delete the value stored in memory

First press the Memory button. Then while holding it down, press the **【Start/Stop】** button simultaneously for about 2 seconds and it appears --. The memory deleting completes. All the value stored in the memory will be deleted and you cannot partially delete the stored readings.

6. Measure the static pressure

a. Short press the setting button. Then holding it down, press the memory button simultaneously for about 1 second, The LCD display appears the number 0. Release the button to enter the static pressure pattern.

b. Long press/short press the **【Start/Stop】** button to exit the static pressure pattern, return to the time pattern.

IV.Operating the monitor

1. Applying the arm cuff

1) Extend the cuff loop and Put your arm through the cuff loop.

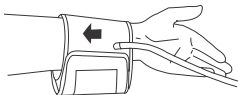

2) position the cuff on upper arm and position the air tube at side your arm.

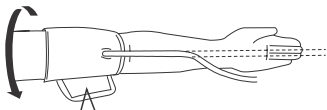

Note: Air tube is centered on the inside of your arm and aligned

3) The bottom edge of the cuff should be 2 to 3 cm above the elbow.

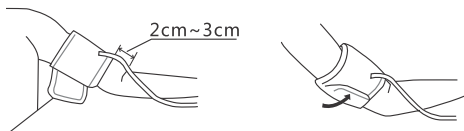

4) Wrap the cuff tightly and close the fabric fastener firmly. Keep a finger gap between cuff and arm.

5) Insert the cuff air tube plug to the left air jack on the monitor. Insert firmly to the bottom.

The correct way to measure:

When measuring, please keep still and relax.

- ① Put your arm on the table.
- ② Keep the cuff at the same level as your heart.
- ③ Keep your palm of hand up and relax.



2. Taking a measurement

1) In shutdown or standby mode, Press **【Start/Stop】** to turn the monitor on. It will automatically start the measuring. Cuff will start to inflate automatically.

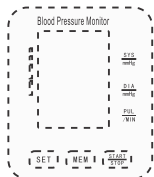

Press **Start/Stop** button

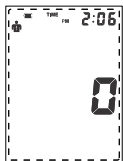

Start measuring



Inflating

* When cuff starts inflating, the monitor starts working automatically. During the inflation, monitor also detects the pulse rate. Therefore, do not move your arm during the whole course and keep still until the measurement is complete. It is normal the arm feels pressed during the inflation. If it appears error message, please refer to the page 10 “**Error Indicators and Cause**” to solve problems.

2) It automatically stops when the inflation is complete, and then start detecting the pulse rate.

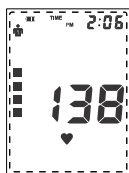

detecting



Complete

Systolic blood pressure:
120mmHg

Diastolic blood pressure:
85mmHg

Pulse rate 70/min

After the measurement is done, the monitor displays your blood pressure value and pulse rate. If ventricular extrasystoles are detected, it appears Irregular heartbeat symbol.

*During the measurement, do not move and keep still
If you wish to stop the measurement, just press **【Start/Stop】** button. The inflation stops and cuff deflates the air.

3) After measurement, take the cuff off and press **【Start/Stop】** button. Manually turn the monitor off.

Without any operation, the monitor will shut down in 60 seconds
For model with backlight, the backlight will be off in 6 seconds without any operation .

Note: The above pictures only for references.

Caution:



1. Wait 2-3 minutes before taking another blood pressure measurement. Waiting between readings allows the arteries to return to the condition prior to taking the blood pressure measurement.

2. Measuring repeatedly may result in the incorrect blood pressure value since the arm blood flow may be not smooth. Please take the measurement when your arm blood flows smoothly.

3. You cannot carry out the measurement when the **Err** appears in screen. Please refer to the next page “Error Indicators and Cause”.

4. Irregular heartbeats can influence the results of the measurement. The measurement values are probably not accurate. Please consult your physician for professional Diagnosis.
5. The cuff is too loose or tight and this will affect the accuracy of measurement value.
6. Measurement gesture and body's condition will affect the measurement value. Please refer to the " the brief information of blood pressure" and eliminate these interference factors.
7. Replacing the cuff that it is not provided by original manufacturer may get risk to the measurement error .
8. Do not use the monitor near the appliance emitted electromagnet interference. The radio interference may affect its accuracy.
9. The main component of the monitor includes master chip, electromagnetic valve, Sensor, air pump, air intake valve, air bleed valve, cuff, AC adapter. You **MUST** use the component approved by original manufacturer for each model. Otherwise, it may get risk to the safety and accuracy issues.



1. Self-diagnosis of measured results and treatment are dangerous. Please follow the instructions of your doctor.

2. If you replace the AC adapter and Lithium battery that is not provided by original manufacturer, it may cause the safety issue or accuracy problem. AC adapter is in accordance with the standard, IEC60601-1:1988. Battery applies to the Standard, IEC60086-4:2014. The battery need to meet the monitor specification. Please contact original manufacturer if you need to replace the lithium battery.

Error indicators and cause

Error Display	Cause
Systolic blood pressure display area appear Err Diastolic blood pressure display area appear 1	Sensor anomaly
Systolic blood pressure display area appear Err Diastolic blood pressure display area appear 2	Pulse is not detected
Systolic blood pressure display area appear Err Diastolic blood pressure display area appear 4	Air deflate before deflating
Systolic blood pressure display area appear Err Diastolic blood pressure display area appear 5	air tube blocks before inflating
Systolic blood pressure display area appear Err Diastolic blood pressure display area appear 6	Strong interference during measuring
Systolic blood pressure display area appear Err Diastolic blood pressure display area appear 7	Air pressure more than 300mmHg (40.0 kPa)

V. Care & Calibration

1. Keep the unit in its storage case when not in use.

2. To protect your unit from damage, please observe the following:

- * Do not subject the main unit and the cuff to extreme temperatures, humidity, moisture or direct sunlight.
- * Do not fold the cuff or tubing tightly.
- * Do not disassemble the unit.
- * Do not subject the unit to strong shocks or vibrations (for example, dropping the unit on the floor).
- * Do not use volatile liquids to clean the main unit. The unit and battery should be cleaned with a soft, dry cloth.
- * Do not wash the arm cuff or immerse it in water. If necessary, clean the cuff with moistened 75% alcohol cotton wool.
- * Dropping, collision, bending will reduce the battery's performance. If you find the battery abnormal, such as the package damaged, the battery parcel deformed, etc. Do not use these batteries.

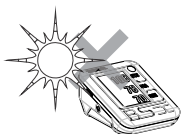

3. Calibration

Blood pressure monitor is precise measuring equipment. It is generally recommended to have the unit inspected once a year to ensure correct functioning and accuracy by original manufacturer or the local metrological institute.

VI. Disposal statement

Directly disposing electronic products and battery will pollute and harm the environment.

Disposal of this product and used batteries should be carried out in accordance with the national regulations for the disposal of electronic products.



WARRANTY CARD

Model No.:

S.No.:

Invoice No.:

Date of Purchase:

Purchased by: Name

Contact No.:

Address:

.....

State:

PIN:

Dealer Name:

Address:

.....

Dealer's Sige & Stamp

IEC No.: 2203001739

Imported & Marketed By:

Passim Medichem Agencies

186, Ind. Area Phase II, Chandigarh 160 002

D. L. No.:

1222-97/OBW & 1223-97/BW

Corporate Office:

902, 9th Floor, WallFort House, S.V. Road, Near Citi Mall,
Goregaon (W), Mumbai-400 062

For Any Complaint/ Suggestion

Please Contact :

Tel. No.: 1800 309 3009

(Timing: 9am -7pm, Mon. - Sat.)

Email ID: customercare@drodin.in

Website: www.drodin.in